

CONTRIZZA CCT & POWER TUNABLE ARCHITECTURAL TROFFER 2 X 4

IMPORTANT SAFEGUARDS

PLEASE FIND A QUALIFIED ELECTRICIAN FOR INSTALLATION. Please read the instructions before you install and use the luminaire.

WARNING, CAUTIONS AND OPERATING INSTRUCTIONS

- To reduce the risk of death, personal injury or property damage from fire, electric shock, falling parts, cuts/abrasions, and other hazards read all warnings and instructions included with and on the fixture box and all fixture labels.
- Before installing, servicing, or performing routine maintenance upon this equipment, follow these general precautions.
- Commercial installation, service and maintenance of luminaires should be performed by a qualified licensed electrician.
- For the installation: If you are unsure about the installation or maintenance of the luminaires, consult a qualified licensed electrician and check your local electrical code.
- To prevent wiring damage or abrasion, do not expose wiring to edges of sheet metal or other sharp objects.
- Do not make or alter any open holes in an enclosure of wiring or electrical components during kit installation.

WARNING: RISK OF FIRE OR ELECTRICAL SHOCK

- Turn off electrical power at fuse or circuit breaker box before wiring fixture to the power supply.
- Turn off the power when you perform any maintenance.
- Verify that supply voltage is correct by comparing it with the luminaire label information.
- Make all electrical and grounded connections in accordance with the National Electrical Code and any applicable local code requirements.
- All wiring connections should be capped with UL approved wire connectors.

CAUTION: RISK OF INJURY

- Avoid direct eye exposure to the light source while it is on.
- Account for small parts and destroy packing material, as these may be hazardous to children.
- Recessed Luminaires for Type IC
- Suitable for Dry or Damp locations

! WARNING DISCONNECT POWER AND ALLOW FIXTURE TO COOL BEFORE CHANGING BULB OR HANDING FIXTURE FOR INSTALLING OR SERVICING.

Figure 1: Bend out mounting tab 90 degrees on each corner.

Figure 1: Use side cutters to adjust each tab to height of T-grid.

Figure 1: Lay fixture into T-grid.

Figure 1: Bend tabs flush against T-grid in order to clear corner for ceiling tile.

Figure 1: Use a #8x1/4" sheet metal screw to fasten fixture to T-grid and use a hanger wire to tie off appropriately in accordance with local building codes (screws and hanger wires supplied by others).

Figure 1: Ensure that the wiring of the last fixture in the row is properly terminated. Then make all electrical connections to the fixture. Attach the wiring access cover plate.

- Do not relocate Green ground screw provided, is in the proper location.
- Minimum 90° supply connectors

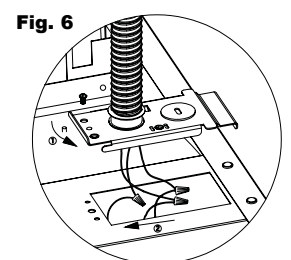
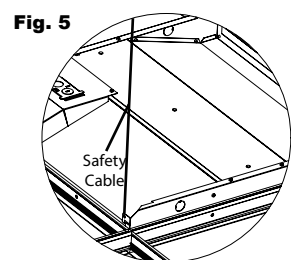
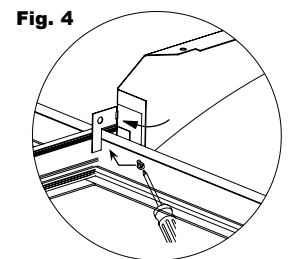
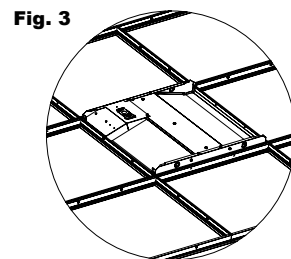
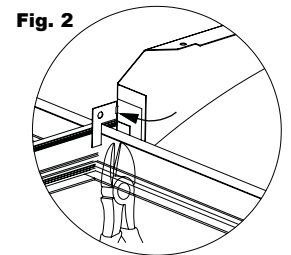
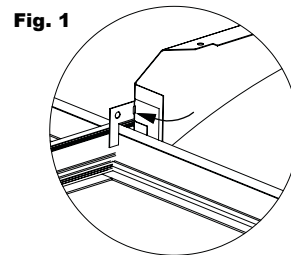

WIRING DIAGRAM

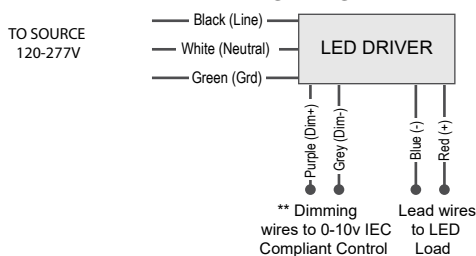

CONTRIZZA CCT & POWER TUNABLE ARCHITECTURAL TROFFER 2 X 4

EMERGENCY BATTERY BACK-UP: *Item sold separately.

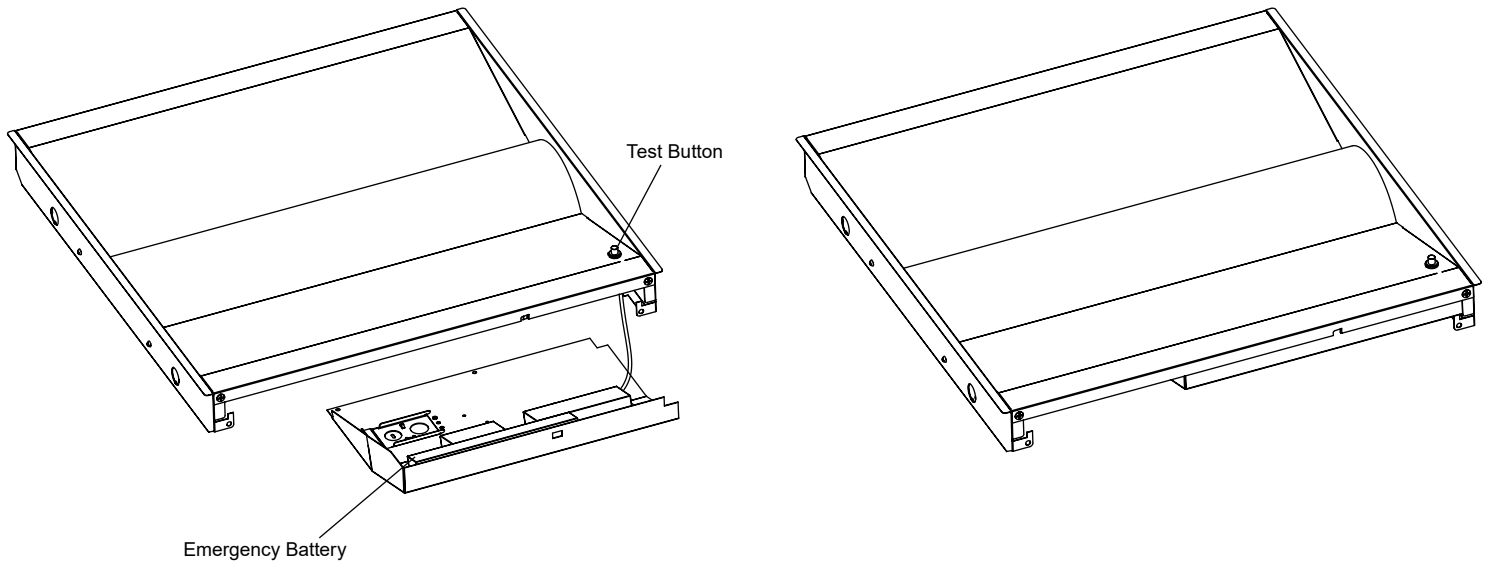

MICROWAVE SENSOR: *Item sold separately by special order; please consult with IKIO

